

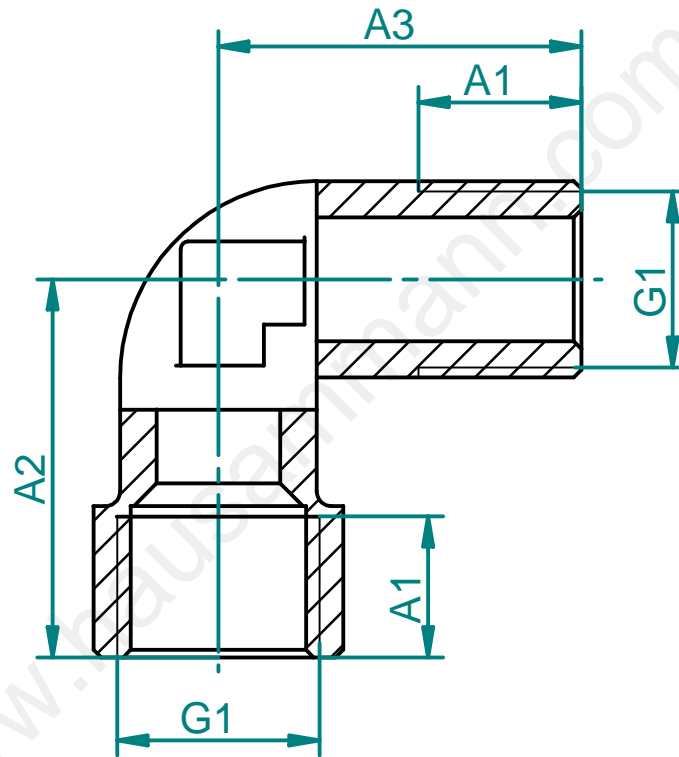

General tolerances ISO 2768-m						Index	Date	Visum	Modification	Index	Date	Visum	Modification
Basic-size	...6	> 6 ...30	> 30 ...120	> 120 ...400	> 400 ...1000								
medium	±0.1	±0.2	±0.3	±0.5	±0.8								



Specifications points D,K,H	
D= doc.points	
K= critical	
H= main	

		Material:			
		Messing vernickelt			
		Scale			
		2:1			
		 Date plotted 17.03.11		Visum E.Z	
		checked			
		40.686			
		Solid Edge		Format A4	
				Index 00	
Accord-draw.no.: Origin-draw.no.: Replacement for:		 HAUSAMMANN KOMponenten PRODUKTION SYSTEME		© 2010, Für dieses Dokument behalten wir uns alle Rechte vor. © 2010, Nous nous reservons tous les droits sur ce document © 2010, We reserve all rights in connection with this document	